

SERIES 17000, 18000 THERMOSWITCH® TEMPERATURE CONTROLLERS SERIES 11000, 80016 PROTECTIVE WELLS



F-01-020

October 2017

THERMOSWITCH® FEATURES

- Fast response
- Close control
- Extreme sensitivity
- Vibration resistance
- Adjustable
- Narrow Differential
- No Power Supply Required
- Stainless Steel Shell

APPLICATIONS

- Hydraulic Laminating Presses
- Livestock Watering Fountains
- Label Adhesive Applications
- Paint Drying Equipment
- Hot Stamp Printers
- Deep Fat Fryers
- Textile Platens

DESCRIPTION

THERMOSWITCH® controllers control temperatures as low as -100°F (-73°C) and as high as 600°F (316°C) with the proven dependability of over 75 years of service to satisfied customers.





PRINCIPLE OF OPERATION

The THERMOSWITCH® controller is a strut-and-tube type thermostat comprised of two basic parts: the outer shell, made of high-expanding metal and the strut assembly, made of low-expanding metal.

A pair of electrical contacts is mounted on the strut assembly and installed in the shell under tension or compression.

Since each end of the strut assembly is mechanically connected to the ends of the shell, a net change of force is produced on the strut assembly as the shell expands or contracts with changing temperature. The temperature at which the contacts "make" or "break" can be regulated by a temperature adjusting sleeve.

AGENCY CERTIFICATIONS

	Recognized under the Components Program of Underwriters Laboratories, Inc. (XAPX2)
	Underwriters Laboratories Listed (XAPX)
	Certified by Canadian Standards Association (Class 481302) CSA File No. LR7378
	BSI Test Report No. 8620513 in compliance with applicable clauses of EN 60730-1: 2000+A2:2008 and EN60730-2-9: 2010 for temperature controlling devices

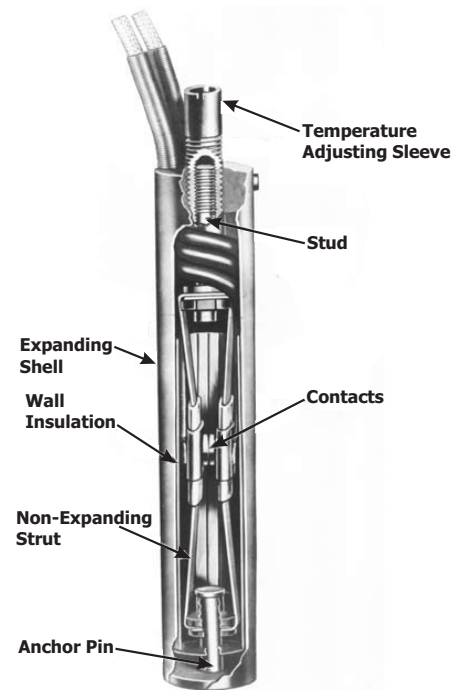

This adaptation of the differential-expansion principle gives several important control advantages:

- **Fast Response** - Since the outer shell of the THERMOSWITCH® is the active sensing member, and not merely a housing, response to temperature change is almost instantaneous.
- **Close Control** - The controller's shell and strut arrangement has "anticipation" characteristics which substantially reduce the amount of overshoot and undershoot during conditions of rapid temperature change. Anticipation is produced by an inherent time lag between the shell and struts, which causes the shell to "lead" the struts by an interval that varies with the rate of temperature change. With rapid temperature rise, the shell exerts a larger net force on the struts and tends to pull them apart sooner than if the temperature were rising slowly. The result is several degrees or more of anticipation which helps produce closer control.
- **Extreme Sensitivity** - The strut and contact operates by slow make and break. This means that every temperature change, no matter how small, causes a corresponding change in the space between the electrical contacts. Therefore, contact action can be produced by a very small temperature change, which accounts for the THERMOSWITCH® controller's excellent resolution sensitivity of 0.1°F (0.05°C).
- **Vibration Resistance** - Since the strut assembly is assembled under tension or compression, a properly installed unit has excellent vibration resistance and will provide the best possible control under difficult physical conditions.
- **Agency Approved** - Various models are listed Underwriters Laboratories (UL) and certified by the Canadian Standards Association (CSA) and compliance with applicable European norms for acceptance the EU under the CE marking scheme. Contact manufacturer for specific approval details.

THERMOSWITCH® CONTROLLERS -100 TO 600°F/-73 TO 316°C

Note: All dimensions are in inches (millimeters).

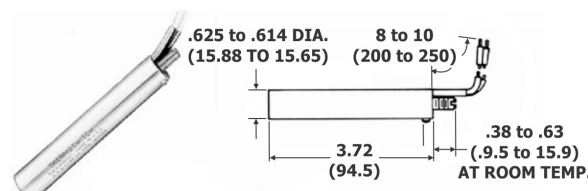
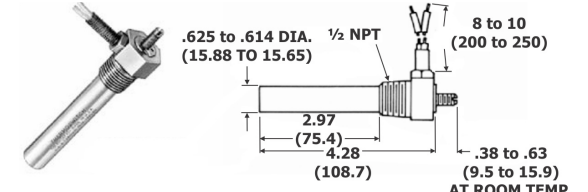
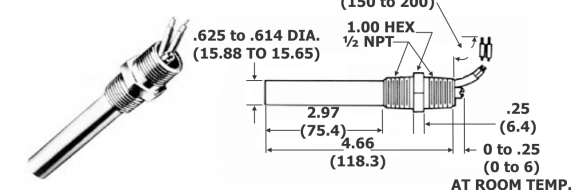
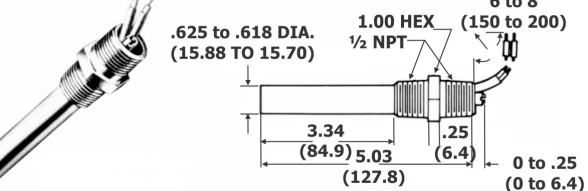
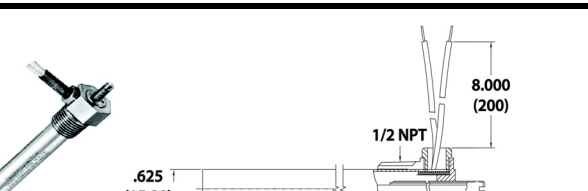
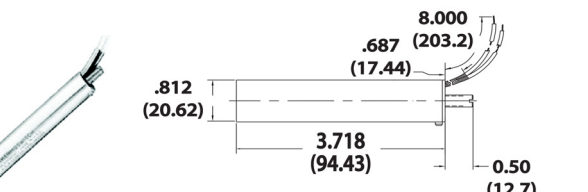
Thermoswitch® Unit Type Dimensions Inches (mm) for reference only	Description	Catalog Number	Shell and Head Material	Temperature Range	Contact Operation on Temperature Rise	Extreme Temperature Exposure	Current Rating	Approximate Degrees changes per full turn of adjusting sleeve	Factory Temp Setting Tolerance (MOD. #3)	Common Modifications/ Special Features Note: See pages 4 and 5 for Modifications and Special Features	
 <p>.625 to .614 DIA. (15.88 TO 15.65) 8 to 10 (200 to 250) 3.72 (94.5) .38 to .63 (9.5 to 15.9) AT ROOM TEMP.</p>	<p>Cartridge Head</p> <p>The basic element of all THERMOSWITCH® controllers. Has all the desirable features of the ideal thermostat - high sensitivity, wide adjustment range, small size, rugged construction, vibration resistance, and low cost. The unit can be inserted into a .625 in. (15.88 mm) reamed hole. Approximate weight is 2.5 ounces (70 grams).</p>	01-017002-000	300 Series S.S. Shell Brass Head	<p>TEMP. RANGE -100 to +600°F -73 to +316°C</p>	Opens	<p>UNITS THAT OPEN ON TEMPERATURE RISE: 100°F/73°C indefinitely and 100°F/55°C above set point for one hour maximum</p>	<p>* AC 10 amps 120 volts 5 amps 240 volts (non-inductive)</p>	110°F/60°C	<p>UNITS THAT OPEN ON TEMPERATURE RISE ±5°F from +32 to +100°F</p> <p>UNITS THAT CLOSE ON TEMPERATURE RISE ±5°F or 3% of Setting Value (whichever is greater) From 100 to 600°F</p>	<p>1 2 3 4 14 SF 31</p>	
		01-017023-000		<p>LISTING -100 to +400°F -73 to +204°C UL Ⓢ</p>	Closes						
 <p>.625 to .614 DIA. (15.88 TO 15.65) 1/2 NPT 8 to 10 (200 to 250) 2.97 (75.4) 4.28 (108.7) .38 to .63 (9.5 to 15.9) AT ROOM TEMP.</p>	<p>Hex Head</p> <p>Has all the features of the Cartridge type plus the addition of a male pipe thread for mounting. Approximate weight is 5 ounces (140 grams).</p>	01-017102-000		<p>TEMP. RANGE -100 to +600°F -73 to +316°C</p>	Opens	<p>UNITS THAT CLOSE ON TEMPERATURE RISE: -100° to +400°F/-73° to 204°C indefinitely and 500°F/260°C for one hour maximum</p>		80°F/45°C			
		01-017123-000		<p>LISTING -100 to +400°F -73 to +204°C UL Ⓢ</p>	Closes			75°F/40°C			
 <p>.625 to .614 DIA. (15.88 TO 15.65) 6 to 8 (150 to 200) 1.00 HEX 1/2 NPT 2.97 (75.4) 4.66 (118.3) .25 (6.4) 0 to .25 (0 to 6) AT ROOM TEMP.</p>	<p>Coupling, Brass Head</p> <p>The Coupling Head type has a hexagonal mounting section with male pipe threads at each end. This unit may be directly attached to electrical conduit. Approximate weight is 5 ounces (140 grams).</p>	01-018002-000		<p>TEMP. RANGE -100 to 600°F -73 to +316°C</p>	Opens	<p>-100° to +600°F/-73° to +316°C indefinitely and 700°F/370°C for one hour maximum</p>		80°F/45°C			
		01-018023-000		<p>LISTING -100 to +400°F -73 to +204°C UL Ⓢ</p>	Closes			75°F/40°C			
 <p>.625 to .618 DIA. (15.88 TO 15.70) 6 to 8 (150 to 200) 1.00 HEX 1/2 NPT 3.34 (84.9) 5.03 (127.8) .25 (6.4) 0 to .25 (0 to 6.4) AT ROOM TEMP.</p>	<p>Coupling, Stainless Steel Head</p> <p>This model is a corrosion resistant controller and has a hexagonal mounting section with male pipe threads at each end. This unit may be directly attached to electrical conduits or explosion proof fittings. It is ideally suited for laboratory and experimental test work, food processing, bleaching & dyeing, and similar applications. Approximate weight is 5 ounces (140 grams).</p>	01-180020-029		<p>TEMP. RANGE -100 to +600°F -73 to +316°C</p>	Opens	<p>-100°F/-73°C indefinitely and 100°F/55°C above set point for 1 hour maximum</p>		<p>** DC 24 VDC (max) 0.5 amps suitable for millivolt application</p>			100°F/55°C
		01-018002-021		<p>LISTING -100 to +500°F -73 to 260°C UL Ⓢ</p>	Closes						±5°F from -100 to 100°F ±3F or 2% of setting value (whichever is greater) from 100 to 600°F
		01-018023-007									±5°F or 3% of setting value (whichever is greater)
 <p>.625 (15.88) 2.968 (75.4) 4.281 (108.7) 8.000 (200) 1/2 NPT 0.50 (12.7) AT ROOM TEMP.</p>	<p>Stainless Steel Head</p> <p>These stainless steel model controllers are corrosion resistant and are available in Hex and Coupling type mounting. The Cartridge head parts are suitable for use with 80016 Series Protective Wells. The products are similar in application as the other products above, but are UL component recognized and CSA approved for special applications. These models are ideally suitable for food processing, bleaching and dyeing industries. Approximate weight is 3 - 5 ounces (85-140 grams).</p>	01-047002-000		304 S.S. Shell & S.S. Head	<p>TEMP. RANGE -100 to +600°F</p>	Opens		<p>-100°F/-73°C indefinitely and 700°F/370°C for 1 hour maximum</p>			101°F/55°C
		01-047102-000, 01-048002-000	<p>LISTING -100 to +500°F UL Ⓢ</p>		±5°F from -100 to 100°F ±3F or 2% of setting value (whichever is greater) from 100 to 600°F						
		01-047023-000	<p>TEMP. RANGE -100 to +600°F</p>		Closes	<p>-100°F/-73°C indefinitely and 700°F/370°C for 1 hour maximum</p>	101°F/55°C				
		01-048023-000	<p>LISTING -100 to +600°F</p>				±5°F or 3% of setting value (whichever is greater)				
 <p>.812 (20.62) 3.718 (94.43) 8.000 (203.2) .687 (17.44) 0.50 (12.7) AT ROOM TEMP.</p>	<p>Jumbo Thermoswitch®</p> <p>This special type larger diameter stainless steel shell model controllers are corrosion resistant and are available in Hex type mounting. The products are similar in application as other products above but has higher current carrying capacity suitable for certain special applications. It is ideally suitable for food processing, bleaching and dyeing industries. Approximate weight is 4 - 7 ounces (115-200 grams).</p>	01-017052-XXX	300 Series Shell & Brass Head	<p>TEMP. RANGE -100 to +600°F</p>	Opens	<p>-100°F/-73°C indefinitely and 700°F/370°C for 1 hour maximum</p>	111°F/60°C				
		01-017152-XXX		<p>LISTING No Agency Approval</p>			±5°F from -100 to 100°F ±3F or 2% of setting value (whichever is greater) from 100 to 600°F				

* UL and CSA units rated for AC operation only. Unless otherwise specified, all ratings apply to non-inductive loads such as heaters or resistors. Tungsten filament lamps have an inrush 10 to 15 times the steady state current. Do not exceed ratings.
 ** DC Application is not Agency approved. Not recommended in normal condition as contact life may be reduced. Product is suitable for millivolt gas valve application.

FENWAL LEGACY PRODUCTS - CONTACT FENWAL OR SALES REPRESENTATIVE FOR MORE DETAILS

Note: All dimensions are in inches (millimeters).

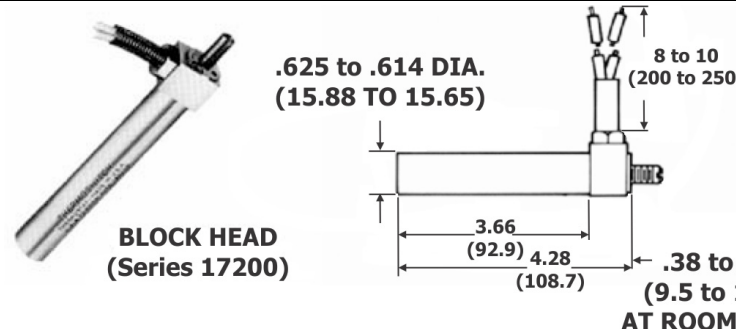
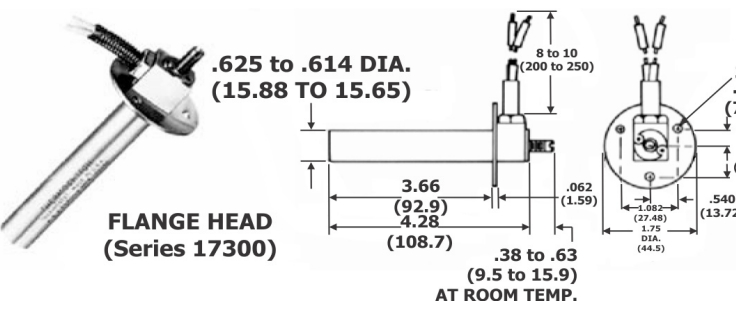
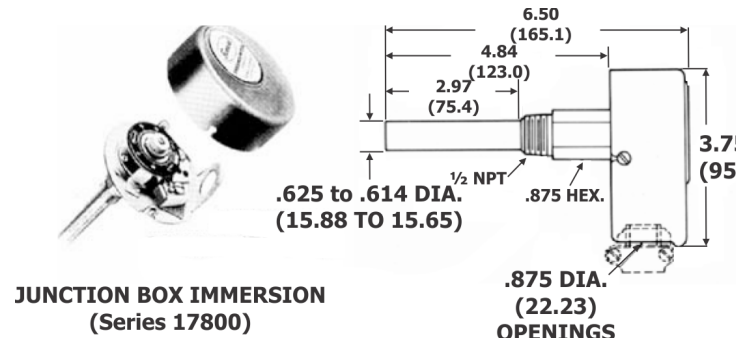
 <p>BLOCK HEAD (Series 17200)</p>	<p>This unit has the same mounting as the Cartridge type but is designed so modifications may be included. It also can be inserted into a .625 in. (15.88 mm) reamed hole. Approximate weight is 3 ounces (84 grams).</p>
 <p>FLANGE HEAD (Series 17300)</p>	<p>Has all the features of the Block Head type except a mounting flange has been provided. Approximate weight is 4 ounces (112 grams).</p>
 <p>JUNCTION BOX IMMERSION (Series 17800)</p>	<p>Has electric conduit junction box containing terminal block and temperature adjusting dial and knob. Extended hexagonal section with pipe thread permits easy mounting into tapped hole of boss, immersing shell into fluid medium to be controlled.</p>

APPLICATION HINTS - Contact Protection

Capacitors are not needed under average conditions. For smoother control of small loads (below 1/10th the controller rating or to prevent contact bounce due to vibration) use capacitance in μF of 0.28 divided by line voltage.

Note: Capacitors should be rated a minimum of 600 volts for 120 volt circuits and a minimum of 1000 volts for 240 volt circuit.

Voltage	Service	Capacitance (μF)
120 VAC	Resistance	None Required
240 VAC	Resistance	0.1
120 or 240 VAC	Relays	0.001 to 0.01
15 to 25 VAC	Relays	0.02
120 or 240 VAC	Motors	Use Relay

RATINGS

Unless otherwise specified, all rating apply to non-inductive loads, such as heaters or resistors. Tungsten filament lamps have an inrush of 10 to 15 times the steady state current. Do not exceed switch rating at any time.

TEMPERATURE OFFSET VALUES DUE TO PRESSURE (APPROX. ONLY)

Pressure PSI	Set Point Offset
100	+3°F/2°C
200	+6°F/3°C
300	+9°F/5°C
400	+12°F/7°C
500	+15°F/8°C
Collapsing pressure (S.S. shell) 3,500 psi at room temperature	



■ Modifications which cannot be combined.

MOD	4	5	8	10	14
4			■	■	
5				■	
8	■				
10		■			■
14		■		■	

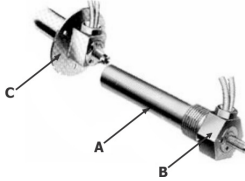
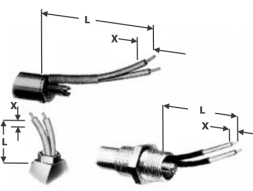
MODIFICATIONS Note: All dimensions are in inches (millimeters).

<p>(1) Special Marking 01-990010-XXX Special Marking may be at points A, B, or C, and is limited to the space available. Location of marking is at discretion of Fenwal and in line of existing marking process.</p>	
<p>(2) Extended Lead Wires 01-99002X-XXX Lead wires may be extended to any length. Length (L) is specified as the portion of lead wire outside the Thermoswitch Unit. Special lead wire stripping may also be obtained by specifying length shown as dimension "X". Unless this modification is specified, units are shipped with standard lead wire length.</p>	
<p>(3) Factory Temperature Setting 01-990030-00X The controller may be preset at Fenwal to any temperature within its listed range to a minimum of 32°F (0°C). Unless this modification is specified, units are preset at approximately 75°F (25°C). Modification 4 is recommended when ordering a factory set unit to preclude a possible shift in set point do to mis-handling.</p>	

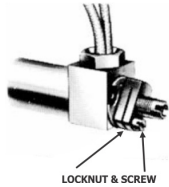
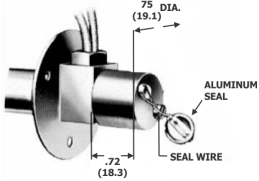
MODIFICATIONS (CONTINUED)

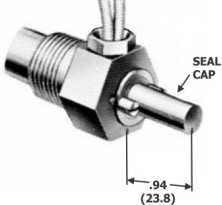
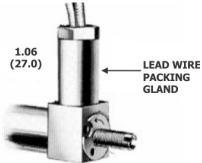
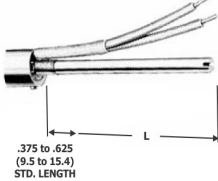
<p>(4) Temperature Restraining Device 01-990040-000 A restraining device may be added to secure the temperature adjustment sleeve after calibration. This modification deters tampering with the setting. It also minimizes the possibility of a shift in calibration due to vibration.</p>	 <p>LOCKNUT & SCREW</p>
<p>(5) Tamper-proof Cap 01-990050-000 A tamper-proof cap can be furnished to prevent tampering with a THERMOSWITCH® controller equipped with Modification 4 above.</p>	 <p>75 DIA. (19.1) .72 (18.3) ALUMINUM SEAL SEAL WIRE</p>
<p>(8) Moisture Resistant Seal 01-990080-001 (8A) Under certain conditions where there is excessive moisture or vapor, a moisture resistant seal may be added to protect the interior of the THERMOSWITCH® controller. Modification 13 should be ordered with this modification.</p>	 <p>PACKING GLAND .63 TO .88 (15.8 TO 22.2)</p>
<p>(10) Moisture Resistant Tamper-proof Cap 01-990100-00X To seal a controller against moisture and tampering, a moisture resistant, tamper-proof cap may be mounted over the adjusting sleeve. It may be used with unset or factory preset units.</p>	 <p>SEAL CAP .94 (23.8)</p>
<p>(13) Packing Gland and Lead Wires 01-990130-00X In installations where moisture may enter THERMOSWITCH® controller around lead wires, a packing gland is recommended. Modification 8 should be used with this modification.</p>	 <p>1.06 (27.0) LEAD WIRE PACKING GLAND</p>
<p>(14) Extended Temperature Adjusting Sleeve 01-990140-XXX Adjustment sleeve extensions are available only in multiples of one inch. While ordering, the length specified is the "extended by" length "L", up to 15 inches. For example, if the standard adjusting sleeve length for the controller ordered is 3/8 to 5/8 inch, and a 4 inch extension is ordered, the overall length will be 4-3/8 to 4-5/8 inches. Minimum ordering quantities apply.</p>	 <p>.375 to .625 (9.5 to 15.4) STD. LENGTH L</p>

SPECIAL FEATURE

31 Extended Shell - THERMOSWITCH® Controllers

In applications where a standard THERMOSWITCH® controller is too short to reach the medium to be controlled, the shell length may be extended. Extension must be ordered in increments of 1 inch beyond standard length up to 18 inches.

HOW TO ORDER - THERMOSWITCH®

1. Select controller detailed on page 2.
2. Order using catalog number.
3. Select applicable Modifications and/or Special Features detailed on pages 4 and 5 and order using 11-digit number shown.
4. In applications where a standard THERMOSWITCH® controller is too short to reach the medium to be controlled, the shell length may be extended. Extension must be ordered in increments of 1-inch beyond standard length, as described in Special Feature 31.
5. Consult factory for parts availability and minimum order quantity requirement for setting up any new part.

PROTECTIVE WELLS - SERIES 11000

In many applications involving liquid and gases, the use of a well is recommended. When the removal of a hex or coupling head THERMOSWITCH® controller would require draining of the container in which it is inserted, the use of a well assembly permits removal of the controller at any time without other disturbances. When surrounding ambients are subject to extreme changes thus affecting THERMOSWITCH® control, the well makes it possible to insert the THERMOSWITCH® controller completely into the medium being controlled thereby eliminating these ambient temperature effects or "head effect".

A well offers protection in applications where fluids have a corrosive effect on the THERMOSWITCH® controller.

For use with 170XX 5/8" Diameter Cartridge THERMOSWITCH® Controllers

Note: All dimensions are in inches (millimeters).

	<p>Catalog No. 34-011201-000 Hex Head Well (321 Stainless Steel Well & Head) Applicable Modifications 1 Special Marking Applicable Special Features 31A Extended Shell Approximate weight is 4 ounces (112 grams) Pressure Ratings: 100 psi at -100°F to +250°F 60 psi at 600°F</p>
	<p>Catalog No. 34-011204-000 Coupling Head Well (321 Stainless Steel Well & Head) Applicable Modifications 1 Special Marking Applicable Special Features 31A Extended Shell Approximate weight is 5 ounces (140 grams) Pressure Ratings: 100 psi at -100°F to +250°F 60 psi at 600°F</p>
	<p>Catalog No. 34-011100-002 Aluminum Surface Mount Well Approximate weight is 4 ounces (112 grams) Pressure Ratings: 100 psi at -100°F to +250°F 60 psi at 600°F</p>

Note: Certain gases or liquids (including water at elevated temperatures) could be corrosive and/or cause electrolytic action, which could severely shorten the life of the controller. Where corrosion or electrolysis is suspect, the use of stainless steel heliarc welded thermowells or various platings or coatings may increase controller life. The rate of corrosion or electrolysis is influenced by a great many system parameters such as chemical makeup and temperature of the solution, stray electric currents, etc. Consult the supplier of your chemicals or Fenwal for suggestions.

In addition, use a well to protect the THERMOSWITCH® controller from external forces or blows which could affect its operation.

Special Feature

S.F. 31A - Extended Well Assembly

The shell of the well assembly may be extended in increments of 1 in (2.5 cm) to a maximum of 18 in (46 cm). The THERMOSWITCH® Unit is also extended (S.F. 31) an equal amount.

Example: A well extended by 9 inches has a "C" dimension of 12.56 inches. Minimum order quantities apply.

When special features are specified, THERMOSWITCH® controllers are assigned a special catalog number. As a result, THERMOSWITCH® controllers as received may bear a different catalog number than the one specified on the customer order.

SERIES 80016 PROTECTIVE WELLS FOR HAZARDOUS LOCATIONS

The 34-080016-004 is an "Explosion Proof" well assembly designed to meet the requirements of Class I, Group D and Class II, Groups E, F, and G. Division 1 and 2 locations. The desired THERMOSWITCH controller must be ordered separately. The assembly is UL listed and CSA certified for these specific hazardous location categories.

The sensing element, which is a cartridge-type THERMOSWITCH® Unit, is seated in the well assembly and held in place by a snap ring. The well assembly, in turn, is threaded into the explosion-proof junction box, giving protection to the controller.

SPECIFICATIONS

Dimensions (Refer to photo)

A = 8.37 ± 0.25 in (212.6 ± 6 mm)

B = 4.50 ± 0.10 in (114.3 ± 2.5 mm)

C = 3.60 ± 0.06 in (91.5 ± 1.5 mm)

D = 0.656 + 0.004, -0 in (16.66 +0.10, -0mm)

Well Assembly Pressure Ratings

100 psi at 250°F (690kPa at 120°C)

60 psi at 500°F (415 kPa at 260°C)

Well Assembly Material

Type 321 Stainless Steel

Current Rating

10 Amps at 120 VAC



5 Amps at 240 VAC

Extreme Temperature Exposure

THERMOSWITCH Units may be exposed to - 100°F (-74°C) indefinitely.

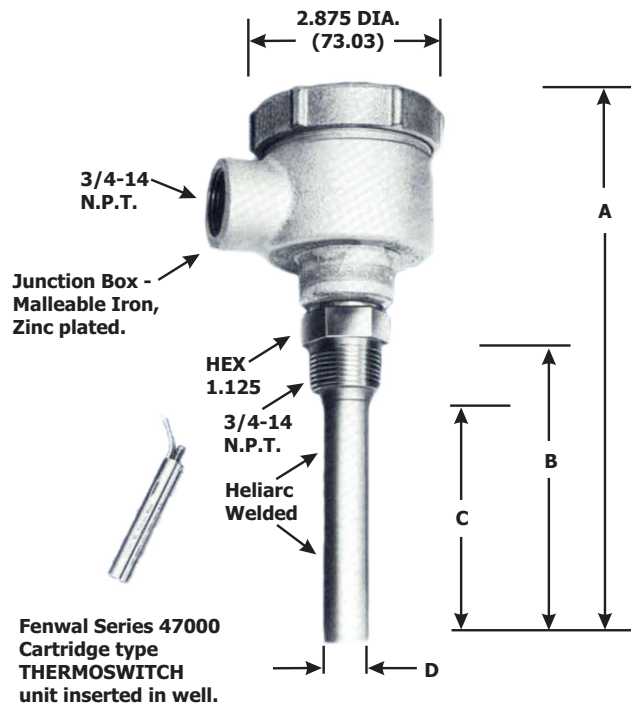
They may be exposed to high temperature for one hour maximum as follows.



THERMOSWITCH Unit	Temperature Range (Agency)	Contact Operation on Temperature Rise	Tolerance	Maximum Temperature	Agency Approvals
01-047002-000	-100 to +600°F (-100 to +500°F)	Opens	±5° from -100 to +100°F (-74 to +40°C) ±3 or 2% of setting (whichever is greater) for 100 to 500°F (40 to 260°C)	Limited to 100°F (55°C) above set point for less than 1 hour	Listed by Underwriters Laboratories (XBDV) U.L. File No. E19310  Certified by Canadian Standards Association (Class 4868 01); CSA File No. LR7378 
01-047023-000		Closes	±3° or 3% of setting (whichever is greater)		

* Weight (approximate) 2 pounds (.9 Kg)

Note: Specifications subject to change without notice.

CAUTION: Operation outside specifications could result in failure of the Fenwal product and other equipment with injury to people and property.

HOW TO ORDER - PROTECTIVE WELLS

- The Explosion-proof assembly and the THERMOSWITCH® Assembly must be ordered separately as follows:
Assembly catalog number 34-080016-004 / 34-011X0X-000.
- THERMOSWITCH® Unit catalog number from the table above.
- Modification or Special Feature number, if desired, with a detailed explanation.

Example: 80016 Assembly with 01-047002-000 THERMOSWITCH® Unit and MOD.3 set to 155°F and MOD. 4 Temperature Restraining Device.

- Shell length may change for protective wells with change in THERMOSWITCH® shell length.
- Consult factory for parts availability and minimum order quantity requirement for setting up any new part.

This literature is provided for informational purposes only. KIDDE-FENWAL, INC. assumes no responsibility for the product's suitability for a particular application. The product must be properly applied to work correctly.

If you need more information on this product, or have a particular problem or question, contact KIDDE-FENWAL, INC., Ashland, MA 01721. Telephone: (508) 881-2000.

Fenwal Controls, Kidde-Fenwal Inc.
400 Main Street
Ashland, MA 01721
Tel: 800-FENWAL-1
Fax: 508-881-7619
www.fenwalcontrols.com

FENWALTM
CONTROLS